





SELECT PRO BOLT ON QUICK EXIT

-  The quick exit push pad is designed to facilitate rapid exit through gates.
-  Stainless steel adjustable latchbolt which springs 22mm into the gate post. Precise fitting on site.
-  Supplied with bolt guide plate and gate post strike plate.
-  Quick exit/key access or quick exit digital lock combinations available.
-  A security shroud is also available to prevent access to the push pad from the outside.

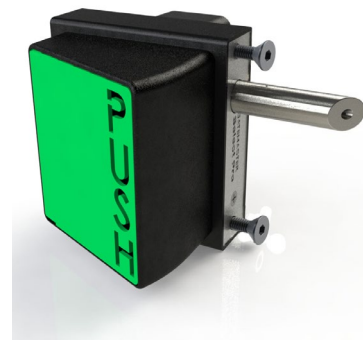

C _ _ _ (Digital locks only)

PRODUCT DETAILS

Product code: | Description:

| | |
|---|--------------------------------------|
| Key access on one side, push pad on the other | |
| SBQEKLL01 | Left Hand for 10 - 30mm gate frames |
| SBQEKLR01 | Right Hand for 10 - 30mm gate frames |
| SBQEKLL02 | Left Hand for 40 - 60mm gate frames |
| SBQEKLR02 | Right Hand for 40 - 60mm gate frames |

| | |
|--|--------------------------------------|
| Digital keypad access on one side, push pad on the other | |
| SBQEDGLL01 | Left Hand for 10 - 30mm gate frames |
| SBQEDGLR01 | Right Hand for 10 - 30mm gate frames |
| SBQEDGLL02 | Left Hand for 40 - 60mm gate frames |
| SBQEDGLR02 | Right Hand for 40 - 60mm gate frames |

Marine grade: Salt spray tested for 1000 hours.
Latchbolts: Adjustable, latchbolt springs 22mm.



L.H. Lock

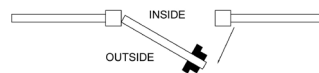

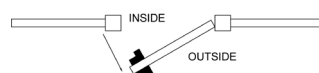

R.H. Lock

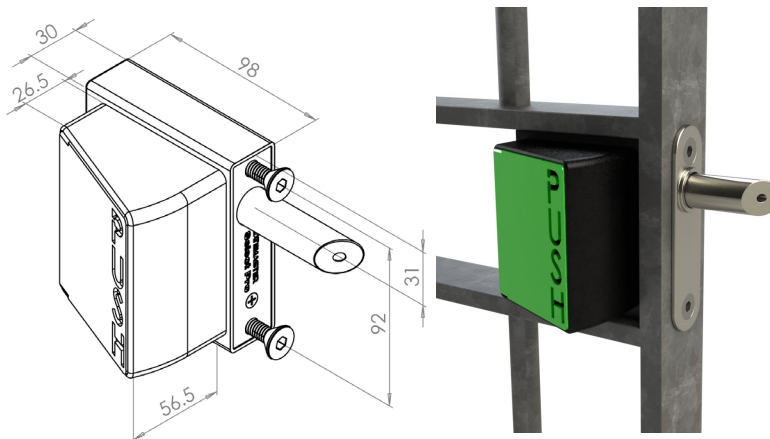

INSTALLATION

- Drill 2 x 9mm dia. holes at 92mm centres for M8 fixing bolt.
- Drill 18mm clearance hole for latchbolt at 22mm centres down from the top 9mm hole.
- Fix lock in place using stainless steel clamp plate, bolt support plate and 2 stainless steel countersunk fixing bolts supplied.
- Drill clearance hole in keep or outer frame to receive the latchbolt. Slot this hole vertically to allow for gate sag. Fit strike plate by either welding or screw fixing to the gate post.
- Ensure latchbolt moves freely without binding on gate or frame.
- MAINTENANCE** Every two months, lubricate the latchbolt with light oil. Annually, dismantle lock and spray the mechanism inside with light oil.



 Check out our Gatemaster Locks channel to view installation videos!



LOCK CODE:

C _ _ _

TO CHANGE THE CODE

1. Check the original code is working on the keypad.
2. To remove the keypad – Unscrew the two fixing screws on top and bottom of the push pad using the 3mm hex key supplied. Remove the black shroud by removing the three fixing screws. Remove the spindle and slide the insides of the lock out.
3. Then unscrew the keypad from the lock by removing the two fixing screws inside the case. Turn the keypad over and remove the 4 red screws.
4. Lift off the covering panel. Be careful as there are 10 springs attached to this panel. Note that the red tumblers relate to the code shown above. Also note that the C tumbler is uncoloured and should not be removed.
5. To change the code hold the keypad with the code buttons down and depress & hold the C button (if this is not done you may damage some of the internal components). Reposition the tumblers to the new code (red tumblers are coded and blue tumblers are uncoded). Ensure that the square cut-out on each tumbler is facing the outside of the lock body, also ensure that the coloured mark is facing upwards. If any one tumbler is upside down or the wrong way round the lock will not work and if forced will break the internal components. The code must always start with a 'C'

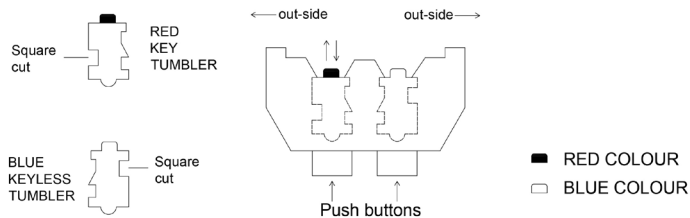

6. Replace the covering panel and tighten the 4 red screws.
7. The code is now changed, check to see that it is working correctly and make a note of the code for future reference. Once satisfied that the lock is working correctly refit keypads to the lock case.

MAINTENANCE

3 monthly:

1. Remove keypads from the lock
2. Spray the inside of the lock thoroughly with WD40 or equivalent, through the tumbler holes at the back of the lock
3. Spray all the fixing accessories and the latch with WD40 or equivalent. Push each of the buttons and rotate the knob several times to make sure the lock is working smoothly

